

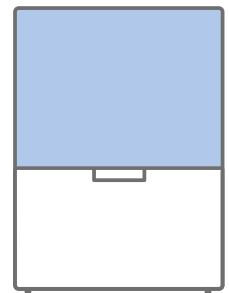

GARDIA

UNFOLLOW THE ORDINARY

Touch-Free Hand Sanitizer

User Manual





UNFOLLOW THE ORDINARY

Every moment of life has its own scent and flavor. A sunny and amber daylight, a misty and silvery dusk or a moonlit nightfall... every now and then they paint a different view. It gets blazing and reminds us of the red cherries, deep in the heat of summer, the coolness of the rain suddenly unfolds and redesigns a dream through a glass window. The story of life is the narrative of the courage, joy of the designs and to unfollow the ordinary.





Welcome to GARDENIA family

Thank you for choosing GARDENIA. We have made this appliance easy to use. Please read this manual carefully before using the touch-free hand sanitizer. We have brought to you the instruction for the installation, use and maintenance of GARDENIA. We hope that you will find GARDENIA delightful.

GARDENIA team





GARDENIA touch-free hand sanitizer

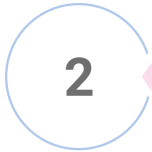

Preparing the device

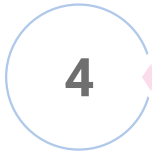

Wall-mount option



Sanitizing liquid and absorbent pad



Power input



Safety information



Cleaning and maintenance



Color palette



More information

TOUCH-FREE HAND SANITIZER

The items supplied with the GARDENIA hand sanitizer and any available accessories may vary depending on the region or service provider

The supplied items are designed only for this GARDENIA product and may not be compatible with other devices.

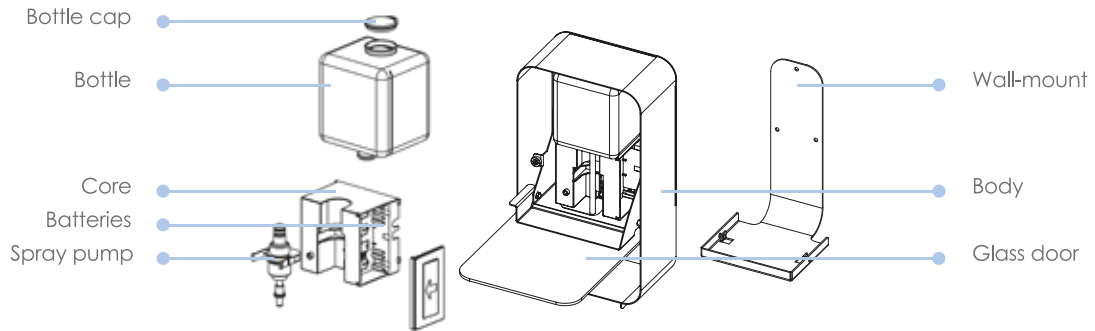

PREPARING THE DEVICE

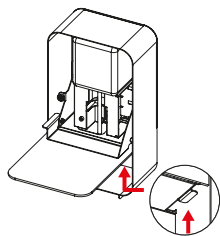

Open the front glass door, using the indicated lever.

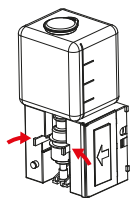

Press white handles to the center horizontally.

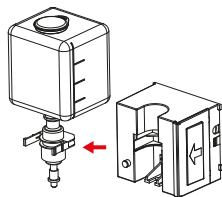

Pull the dispenser out.

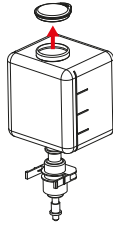

Pull out the cap on the top of the bottle. Fill the bottle.

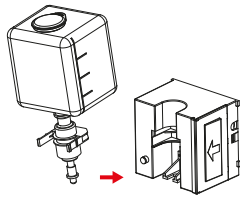

Bend dispenser and place the nozzle first and push the handles to its tray to fit back.

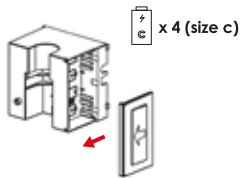

To replace the batteries, open side door by pulling it forward, place new batteries in the right direction.



Close the front glass door. Place the absorbent pad according to the picture. Switch the on/off button on the back of the device and start using the dispenser.



WALL-MOUNT OPTION

This option allows you to install your device at any location and opens the possibility to have a perfect access at the desired height.

Use a pencil to mark the location on the wall where you want to place and adjust the wall mount.

fix the device on the wall using the three screws in the package. Follow the appropriate steps for the type of wall that you're attaching the mount to.

Carefully lift up the dispenser body and place it on the wall mount.

tighten the device on both sides with two screws.

The dispenser is ready to use.



If you lack the necessary expertise to attach this product, contact a construction professional to install the wall mount or to provide specific mounting instructions for your wall structure. Failure to do so may result in personal injury and/or equipment damage.

SANITIZING LIQUID AND ABSORBENT PAD

- By pulling the cap, placed above the bottle, you'll be able to fill the dispenser. The spraying device allows you to use any liquid disinfectant solution that you desire. Whether it is alcohol based or non-alcohol chemical disinfectants. Do not use semi-liquid gels.
- Place the absorbent pad provided in the package, on the lower part of the device, under the spray pump. In addition to being highly absorbent, this pad won't leave liquids residue behind on the surface. GARDENIA dispenser sensor has been designed in a way that it would only function with the pad, properly placed under it.

POWER INPUT

- Different types of batteries or a mix of new and used batteries are not to be used.
- Exhausted batteries are to be removed from the device and safely disposed of.
- If the device is to be stored unused for a long period, the batteries should be removed.
- The device shall be supplied at safety, extra low voltage corresponding to 6Vdc, max. 1000 mA, when use charger inlet.
- Ensure that the 4 alkaline batteries (size C Cell 1.5 V dc) are inserted correctly aligning the (+) and (-) terminals as indicated under the battery door. Open the battery door, insert the batteries and close the door.



SAFETY INFORMATION



Please read all safety information before using the device to ensure safe and proper use



The device is not for children to play with. KEEP OUT OF REACH OF CHILDREN.

Do not place the device on any unstable surface. It could fall, thereby potentially causing injury to a person and damage the device.



This product is for indoor use only. Do not use outdoors.

Take care when using the device with any power supply accessory to route the power cord in a way that reduces the risk of injury to others, such as by tripping or choking.



It is not intended for use in wet, damp or condition of extreme humidity. These conditions could affect the life of the product and could compromise its safety.

The device may only be used for the disinfection of hands in the manner described in this manual. Negligent use may cause harm to users or the device. The warranty issued with the device will not cover damage ensuing from negligent use.

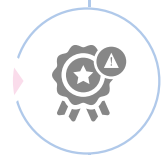

DO NOT expose the device to fire or excessive temperature. Exposure to fire or high temperature may cause explosion. This device cannot be used in the presence of explosive fumes, explosive dust or other explosive chemicals.

In case of eye contact with the dispensed liquid, immediately flush eyes with water. If irritation persists, get medical attention.



Do not fill the dispenser with semi-liquid gel. GARDENIA will not be held responsible for damage, injury or poor performance caused by use of improper refills in the device.

The product accessories (e.g. charger) should not be disposed of with other household waste.



CLEANING AND MAINTENANCE

To clean exterior surfaces as a routine care, disconnect the power supply, switch off and wipe with a dry soft cloth. For heavy contamination, use a soft cloth diluted with mild detergent. Rub it with the soft cloth and wipe off the detergent. Abrasive products or scouring pads, steel wool or sand paper are not recommended. Do not store your device in temperature above 50°C.

COLOR PALETTE

This device comes in 10 different colors.



MORE INFORMATION

Please visit our website to access additional device information and to explore other body colors:





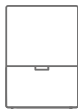

gardenialifestyle.com