

# G | AINEDRA

UNFOLLOW THE ORDINARY

AMABILIS | GRANITE SINK

User Manual



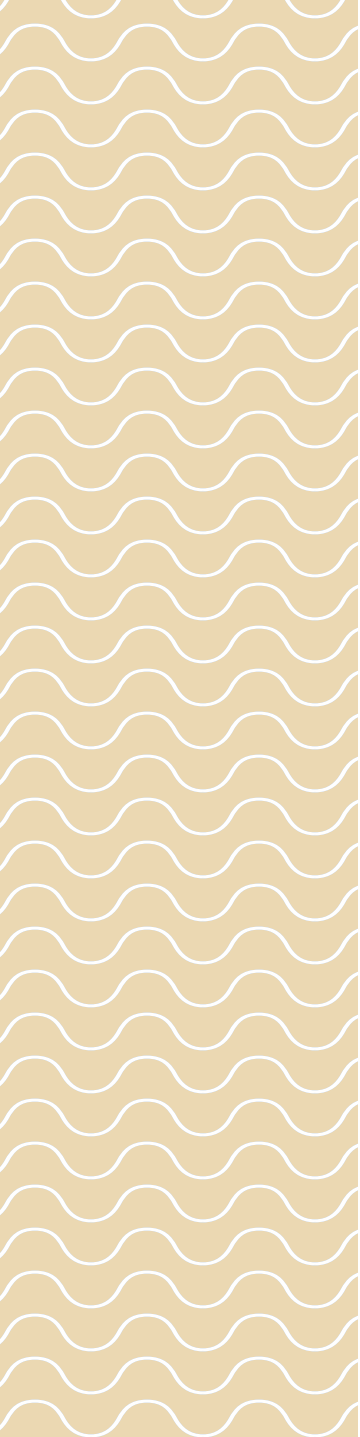

# UNFOLLOW THE ORDINARY

Every moment of life has its own scent and flavor. A sunny and amber daylight, a misty and silvery dusk or a moonlit nightfall... every now and then they paint a different view. It gets blazing and reminds us of the red cherries, deep in the heat of summer, the coolness of the rain suddenly unfolds and redesigns a dream through a glass window. The story of life is the narrative of the courage, joy of the designs and to unfollow the ordinary.





# Welcome to GARDENIA family

Thank you for choosing GARDENIA. We have made this set of granite sinks easy to use. Please read this manual carefully before installing and using the granite sink. We have brought to you the instruction for the installation, use and maintenance of GARDENIA. We hope that you will find GARDENIA delightful.

GARDENIA team





AMABILIS granite Sink



Color palette



Touch-light technology



Sink installation



Safety information



Cleaning and maintenance



More information

## AMABILIS GRANITE SINK

When it comes to designing your kitchen décor, it is important to use the right colors. The variety of different colors in GARDENIA granite sinks will help you in achieving your desired kitchen décor. Alongside with the beautiful colors, GARDENIA kitchen sinks are equipped with the state-of-the-art granite material technology. This technology has given a set of remarkable features to AMABILIS.



Scratch resistant



Heat resistant



Anti-UV



Anti-shock



Anti-stain



Anti-bacterial

### ● Heat resistant

GARDENIA granite sink is designed in a way that makes it much more resistant to heat than other conventional granite sinks and will not change color.

### ● Scratch resistant

The resistance of GARDENIA granite sink to scratches is what increases the useful life of the sink.

### ● Anti-shock

Granite is a very durable material that will make your kitchen sink resist high pressure.

### ● Anti-UV

Ultra-violet rays can cause deterioration and fade your sink color. GARDENIA granite sink will maintain its looks with the protection that blocks ultraviolet rays reaching your sink.

### ● Anti-stain

Water stains leaves almost no trace on GARDENIA granite sinks. This family of sinks will not tarnish over the years.

### ● Anti-bacterial

GARDENIA granite sinks contain antibacterial and antimicrobial substances that prevent germs and bacteria from growing in the sink.

AMABILIS collection of granite sinks comes in three different models. While single bowl sinks are ideal for smaller kitchens, double bowl sinks provide more space for washing bigger items.

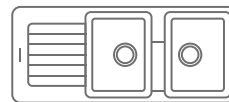
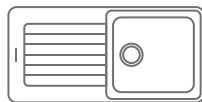

## COLOR PALETTE

This device comes in 10 different colors.



## TOUCH-LIGHT TECHNOLOGY

With GARDENIA Touch-light technology, there is no need to worry about small particles or tiny kitchen utensils in the sink to get lost out of the user's sight. The LED light embedded in the bowl, helps shining up the kitchen sink, presents to you a functional modern kitchen, without dazzling your eyes.

The high-tech actuator of the lighting is placed just underneath the GARDENIA logo on the hand drainer. In order to turn the touch-light OFF/ON, simply double tap the logo and with the array of light, let your sink shine.



Touch-light kit installation must only be undertaken by a GARDENIA authorized service. If the product is being installed by a third party, it will no longer be under warranty.

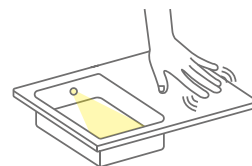

# SINK INSTALLATION

Follow the instruction provided below.

Make sure to have proper water and waste pipe connections. Preferably use the services of GARDENIA experts to ensure the correct installation of the sink.

A cutting template is designed to make the installation process easier for you. The template is included in the package.

Make sure to have proper water and waste pipe connections. Preferably use the services of GARDENIA experts to ensure the correct installation of the sink.

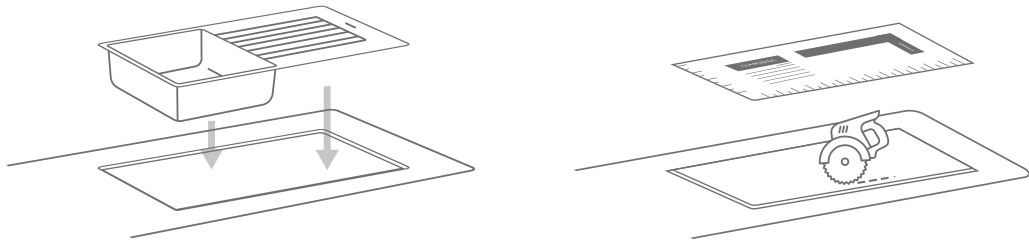

Position the template, flat on the countertop and align it with cabinet and plumbing connections.

Mark openings and cut the countertop. Always double check the sink to make sure that it fits inside the hole before moving on.

Turn the sink over. Fit the mounting clips into the grooves on the back of the sink. Turn the sink and place it into the countertop and turn the moving edge of the clips against the counter. To keep the sink against the surface, tighten the evenly until all of the clips grasp the underside of the countertop firmly and securely.

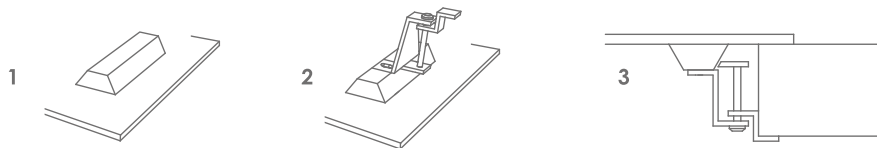



To install the drain system, insert the metal strainer into the drain hole, and the rubber gasket and the main drain body underneath the sink. Tighten the main drain body and the metal strainer into place, using the screw. Insert the basket on top of the drain installation.



Make sure to use the drain system provided in the package.

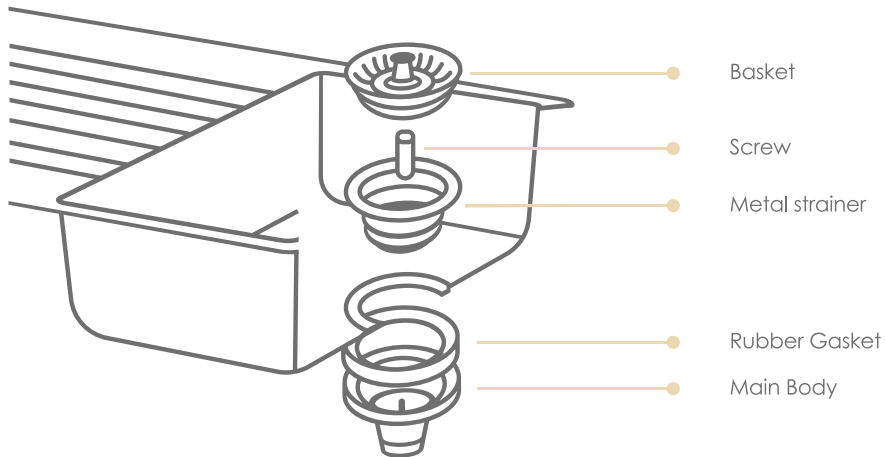



## SAFETY INFORMATION



Shut off water valves prior to installation

Leave a proper empty space under the sink.

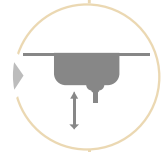

The sink should be installed away from any electrical outlets.

Make sure the installation site is clean and free of dust and debris.



Improper installation of this product will void the warranty and may cause damage to the surrounding area.



## CLEANING AND MAINTENANCE

With high quality standards these sinks have become anti-stain and anti-scratch. However, to increase the life cycle of the product, keep the following points in mind:

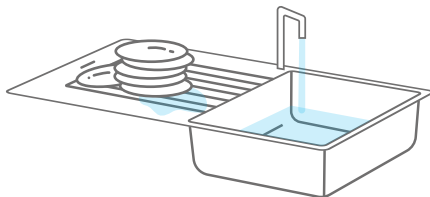

Avoid contact of metallic scouring pads, scotch tape, steel wool pads and sharp objects such as knives with the sink. For a longer life, it is better not to place very hot dishes on the sink.

Avoid placing wet dishes on the sink for as long as possible.

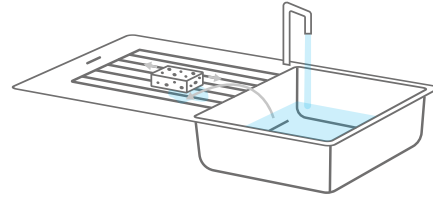
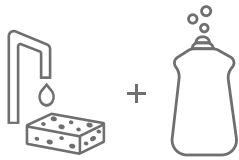

- It is better to wash and dry the sink after each use. Wash and then rinse the sink thoroughly daily with fresh tap water; do not use any liquids which would lead to staining.
- Alternatively use water and white vinegar to clean your sink, by mixing equal amounts of white vinegar and water and use it to clean
- To clean the sink, you can close the drain and pour warm water up to a height of 10 cm. Add 2 tablespoons of dishwashing powder to the water and mix thoroughly. Then clean, rinse and dry your sink with a soft sponge.
- To remove colored stains, you can use a solution of baking soda and glass cleaner without chloride or based on alcohol.
- It is better not to put dishes soaked in colored substances such as tea, coffee, and etc., on the sink for a long time.

## MORE INFORMATION

Please visit our website to access additional device information and to explore other body colors

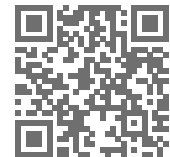



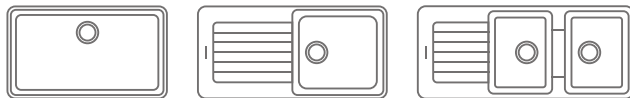

[gardenialifestyle.com](http://gardenialifestyle.com)